

**Pressure transmitter
CP 200**



WITH or WITHOUT display



- Ranges from 0/+100 Pa to -2000 mbar/+2000 mbar (according to model)
- Configurable intermediate and centre zero ranges
- Air velocity and airflow functions (optional)
- Simultaneous display of 2 parameters
- 2 outputs 4-20 mA or 0-10 V (4 wires), RS 232, 2 RCR relays 6 A / 230 Vac
- 2 visual (dual color LED) and audible (buzzer) alarms
- Output diagnostics
- ABS IP 65 housing, with or without 2-line backlit display
- Quick and easy mounting using the "1/4 turn" system with wall-mounting plate

Transmitter features

- Measuring range**see table below
- Units of measurement**.....Pa, mmH₂O, mbar, inWG, mmHG (CP 201 and CP 202)
mbar, inWG, mmHG, KPa, PSI (CP 203 and CP 204)
- Accuracy***±1% of reading ±2 Pa (CP 201)
±1% of reading ±2 mmH₂O (CP 202)
±1% of reading ± 2 mbar (CP203 / CP204)
- Response time**1/e (63%) 0,3 sec.
- Resolution**1 Pa - 0,1 mmH₂O - 0,01 mbar - 0,01 inWG - 0,01 mmHG (CP 201 and CP 202)
1mbar - 0,1 inWG - 1mmHG - 0,1 KPa - 0,01PSI (CP 203 and CP 204)
- Autozero**push-button
- Type of fluid**.....air and neutral gases
- Overpressure tolerated**25000 Pa (CP 201), 7000 mmH₂O (CP 202),
1400 mbar (CP 203), 3000 mbar (CP 204).

*All accuracies indicated in this technical datasheet were stated in laboratory conditions, and can be guaranteed for measurements carried out in the same conditions, or carried out with calibration compensation.

Configurable intermediate or centre zero ranges

Probe ref.	Pressure range	Air velocity range*
CP 201	-1000/+1000 Pa	3 to 30 m/s
CP 202	-10 000/+10 000 Pa	3 to 100 m/s
CP 203	-500/+500 mbar	not available
CP 204	-2000/+2000 mbar	not available

* These air velocity ranges are given for information, based on a DEBIMO differential probe (Cm = 1) and they do not take into account temperature compensation.

The minimum configurable range is 10% of the full scale.

Functions (optional only on models CP 201 and CP 202)

Class 200 transmitters have 2 analogue outputs which correspond to the 2 parameters displayed. You can activate 1 or 2 outputs and for each output, you can choose between pressure, air velocity and airflow (optional functions).

Features Functions	Measuring ranges	Units and resolutions
Air velocity*	3 to 100 m/s (according to model)	0,1 m/s - 0,1 fpm
Airflow*	0 to 100 000 m ³ /h (depends on air velocity and duct dimensions)	1 m ³ /h - 0,1 m ³ /s 0,1 l/s - 1 cfm

* Differential probe (Pitot tube, Debimo...) sold separately

Part number

To order, just add the codes to complete the part number :

Measuring range

- | | | |
|---|----------------------|---|
| 1 | -1000 / +1000 Pa | For the intermediate and centre zero ranges, see "Configuration". |
| 2 | -10 000 / +10 000 Pa | |
| 3 | -500 / +500 mbar | |
| 4 | -2000 / +2000 mbar | |

Power supply / Output

- | | |
|---|--------------------------------|
| B | 24 Vac/Vdc • 0-10 V or 4-20 mA |
| M | 115 Vac • 0-10 V or 4-20 mA |
| H | 230 Vac • 0-10 V or 4-20 mA |

Display

- | | |
|---|-----------------|
| O | With display |
| N | Without display |



Example : CP 201-MN = pressure transmitter type CP 200, with measuring range of -1000/+1000 Pa, with power supply 115 Vac, without display.

Housing dimensions

(including the wall-mounting plate)

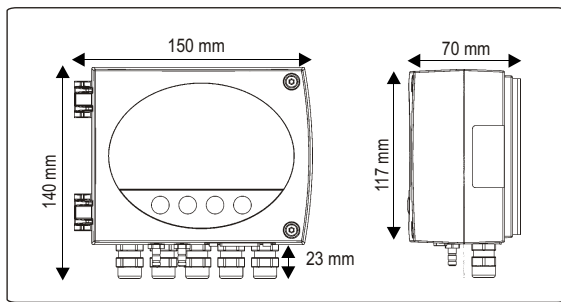

Relays and Alarms

Class 200 transmitters have 4 stand-alone and configurable alarms : 2 visual alarms (dual color LED) and 2 relays (contacts).

You can set:

- the parameter (pressure, air velocity, airflow)
- 1 or 2 set points (rising and falling action) for each alarm
- the time-delay / 60 sec max.
- the alarm action (rising or falling)
- the relay operation mode : positive or negative security
- the audible alarm (buzzer) activation

Air velocity and airflow functions

(option available only on models CP201 and CP202)

Pressure transmitters working with a differential probe (such as DEBIMO blades, Pitot tube, orifice plate...) can be configured with a square root function. Via this function, and from the differential pressure, the transmitter can calculate air velocity or airflow in a duct.

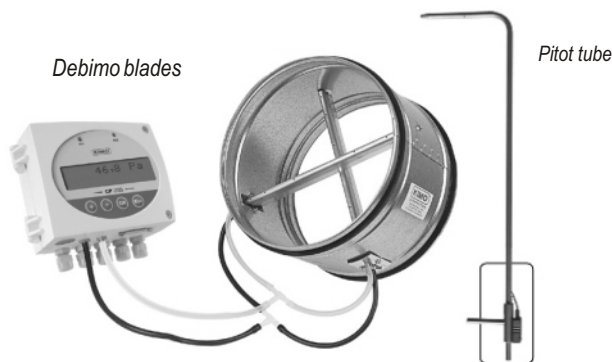

Air velocity calculation function :

$$\text{Air velocity (m/s)} = C_M \times C_C \times C_T \times \sqrt{\text{pressure (Pa)}}$$

C_M : coefficient of differential probe

C_C : coefficient to adapt the measuring system to the specifications of your air movement conditions.

C_T : temperature compensation coefficient, with the formula below :

$$C_T = \sqrt{\frac{574,2 \times \text{temp. (}^\circ\text{C)} + 156842,77}{101325}}$$

Airflow calculation function :

$$\text{Airflow (m}^3\text{/h)} = \text{air velocity (m/s)} \times \text{surface (m}^2\text{)} \times 3600$$

Surface : setting of duct type (rectangular or circular) and duct dimensions (in mm or in inches).

Integration of pressure measurement

The pressure measurement element is very sensitive and reacts to pressure changes. When making measurements in unstable aerualics installations, the pressure measurement may fluctuate. The integration coefficient (from 0 to 9) makes an average of the measurements and then helps avoid any ill-timed variations ; it guarantees a stable measurement.

Housing features

Housing	ABS
Fire-proof classification ...	V.0 as per UL94
Dimensions	see drawing alongside
Protection	IP 65
Display	alphanumeric, 2 lines of 16 digits, 98 mm x 22 mm, backlit protection screen made of PMMA
Fittings	barbed fittings Ø 6,2 mm (CP 201/202) compression fittings for tube Ø 4 x 6 mm (CP 203/204)
Connection fitting	polyamide for cables Ø 7 mm max.
Weight	800 g (with display)

Technical Specifications

Power supply	24 Vac / Vdc ±10% 115 Vac or 230 Vac ±10%, 50-60 Hz
Output	2 x 4-20 mA or 2 x 0-10 V (4 wires) maximum load : 500 Ohms (4-20 mA) minimum load : 1 K Ohms (0-10 V)
Galvanic isolation	inputs and outputs (115 Vac/230 Vac models) outputs (24 Vac/Vdc models)
Consumption	5 VA
Relays	2 RCR relays 6A / 230 Vac
Visual alarms	2 dual color LED
Audible alarm	buzzer
Electro-magnetical compatibility ...	EN 61 326
Electrical connection	screw terminal block for cables Ø1.5 mm ² max
RS 232 communication	numerical : ASCII, proprietary protocol
Working temperature	0 to +50°C
Storage temperature	-10 to +70°C
Environment	air and neutral gases

Configuration

You can configure all the parameters of the transmitter : **units, measuring ranges, alarms, outputs, channels, calculation formula...** via the different methods shown below :

- ☛ **Via keypad** : only on models with display.
A code-locking system combined with keypad guarantees the security of the installation. See configuration manual.
- ☛ **Via software** (optional) : on all models.
Simple user-friendly configuration. See LCC-300 user manual.

Configurable analogue outputs

Range with centre zero (-50/0/+50 Pa), with offset zero (-30/0/+70 Pa) or standard range (0/+100 Pa) => you can configure your own intermediate ranges according to your needs, between 10% and 100% of the full scale.
The minimum configurable range is 10% of the full scale.

Configure the range according to your needs : outputs are automatically adjusted to the new measuring range.

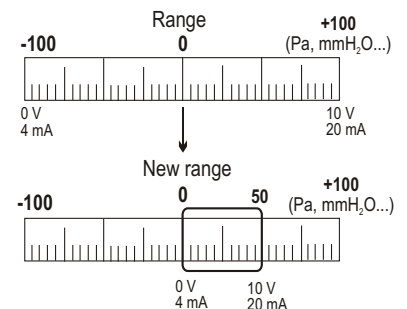

Autozero

Thanks to the temperature compensation of the gain (from 0 to 50°C) and to the manual auto-zero, Class 200 transmitters guarantee an excellent long-term stability, along with great measurement accuracy (in low and high ranges). The autozero compensates for any long-term drifts of the sensitive element, with the manual adjusting of the zero.

To autozero, unplug the 2 pressure connections tubes, and press on the AUTOZERO key (see "connection").

If the pressure transmitter has a display screen, it's possible to autozero by pressing the button for 5 seconds.

Connection

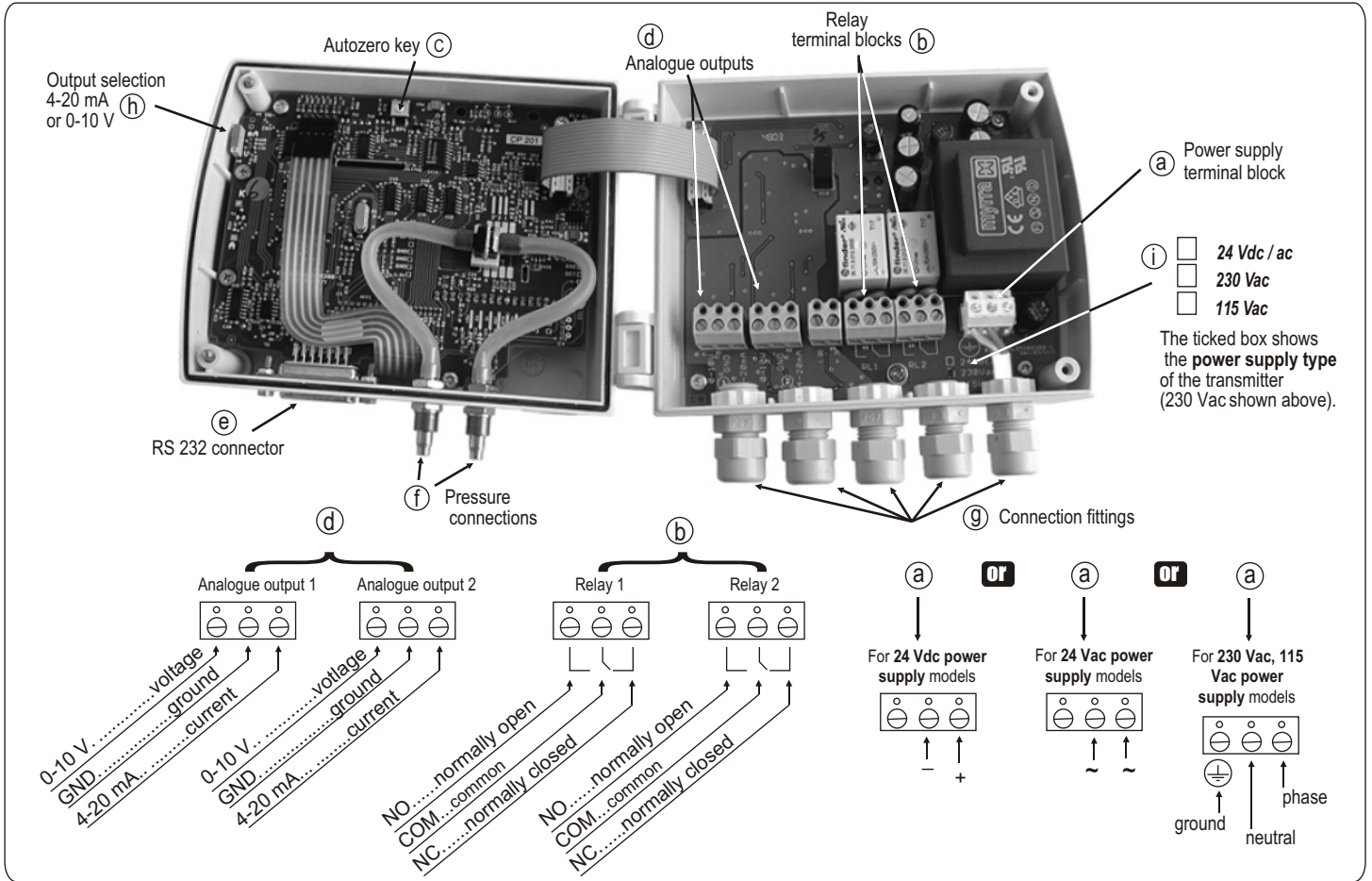

Electrical connections - as per NFC15-100 norm

⚠ This connection must be made by a qualified technician. Whilst making the connection, the transmitter must not be energized.

Power supply connection :

⚠ Before making the connection, you must first check the power supply which is indicated on the transmitter board (see (i) on connection drawing).

• For 24 Vdc power supply models :

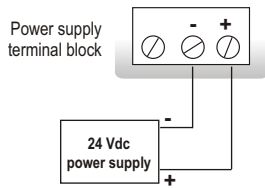

• For 24 Vac power supply models :

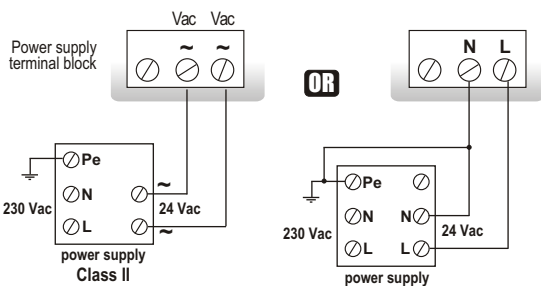

• For 115 or 230 Vac power supply models :

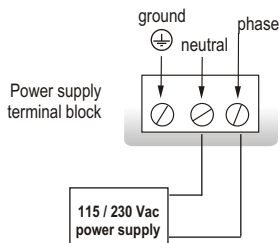

Output signal selection voltage (0-10 V) or current (4-20 mA)

The on-off switch located on the left top of the transmitter (see (d) on connection drawing) allows selection of the required outputs.

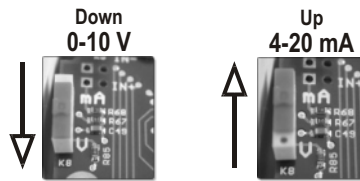

Output connection :

• 4-20 mA current output :

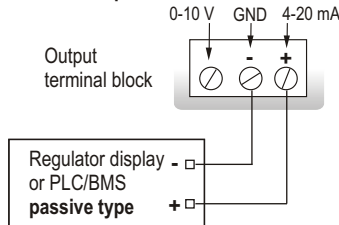

• 0-10 V voltage output :

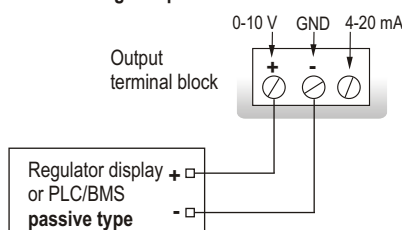

Connection of SUB-D15 RS 232 (see (e) on connection drawing)

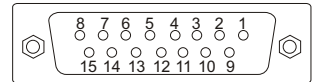

Pin #	Description
1	NC *
2	NC *
3	NC *
4	NC *
5	NC *
6	NC *
7	NC *
8	NC *
9	RX (RS 232)
10	NC *
11	TX (RS 232)
12	NC *
13	NC *
14	NC *
15	GND (RS 232)

⚠ CAUTION !
NC * = DO NOT CONNECT

Numerical communication

RS 232 communication

- Via the RS 232 connection, the CP 200 can transmit its measurements to a **KIMO Class 300 transmitter**. Example : a TH 300 will display (in addition to the temperature and humidity), the pressure measured by a CP 200.
- Via the RS 232 connection, you can also configure your transmitter with the LCC-300 software.
- The RS 232 connection cable is available in 2 m, 5 m or 10 m (maximum) lengths.



Calibration

Adjusting and calibration on site :

The professional configuration interface, with a dynamic pressure calibration bench, enables you to adjust and calibrate your transmitters directly on site or in laboratories.

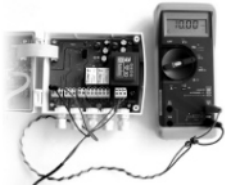
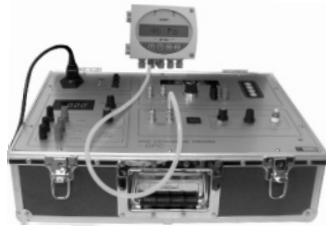

Output diagnostics :

With this function, you can check with a multimeter (or on a regulator / display, or a PLC / BMS) if the transmitter outputs work properly. The transmitter generates a voltage of 0 V, 5 V and 10 V or a current of 4 mA, 12 mA and 20 mA .

Certificate :

- Class 200 transmitters are supplied with adjusting certificates. Calibration certificates are offered as an option.

Maintenance

Avoid aggressive solvents.

Protect the transmitter and probes from any cleaning product containing formol, which may be used for cleaning rooms or ducts.

Options

- SQR/2 (square root extraction) function for the calculation of air velocity and airflow
- LCC-300 configuration software with RS 232 cable
- Calibration certificate



Optional accessories

- Pitot tubes
- Sliding fittings
- Debimo measuring blades
- Connection fittings
- Mounting brackets
- Silicone tube

Mounting

To install the transmitter on a wall : fix the stainless steel plate to the wall (this plate is supplied with the transmitter). Drill : 8 mm holes and mount the plate with the screws and wall-plugs supplied with the transmitter. Insert the transmitter on the plate (see A on the drawing shown below), by aligning it at 30°. Rotate its housing in clockwise direction until you hear a "click" which confirms that the transmitter is correctly installed. Then, open the housing, lock the clamping system of the housing on the plate, with the screws as shown (to remove the transmitter from the plate, remember to remove the screws first).

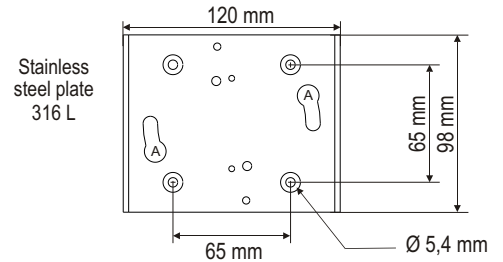
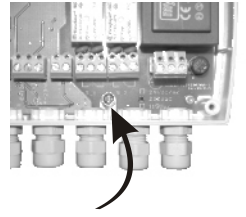

CAUTION !

Once the transmitter is installed and powered on, activate autozero procedure. This guarantees that the transmitter works properly, whatever its position.

Ref. FT ang - CP 200 - 10/08 D - We reserve the right to modify the characteristics of our products without notice.

www.kimo.fr

EXPORT DEPARTMENT

Tel : + 33. 1. 60. 06. 69. 25 - Fax : + 33. 1. 60. 06. 69. 29

e-mail : export@kimo.fr



Distributed by : **PRC Technologies Corp., Ltd.**

Tel : 02 530 1714, 02 530 1619, 02 530 1621

Fax : 02 530 1731

info@prctech-th.com