

**Humidity / Temperature transmitter  
TH 200**

- Ranges from 0-100%RH and -40 to +180°C (probe dependent)
- Configurable intermediate ranges
- Functions : relative and absolute humidity, dew point, wet and dry temperature, enthalpy.
- Smart-Pro system interchangeable probes (PC or Stainless Steel)
- On-site calibration
- Simultaneous display of 2 parameters
- 2 outputs 4-20 mA or 0-10V (4 wires), RS 232, 2 RCR relays 6A/230 Vac
- 2 visual (dual color LED) and audible (buzzer) alarms
- Output diagnostics
- ABS IP 65 housing, with or without 2-line backlit display.
- Quick and easy mounting using the "1/4 turn" system with wall-mounting plate.

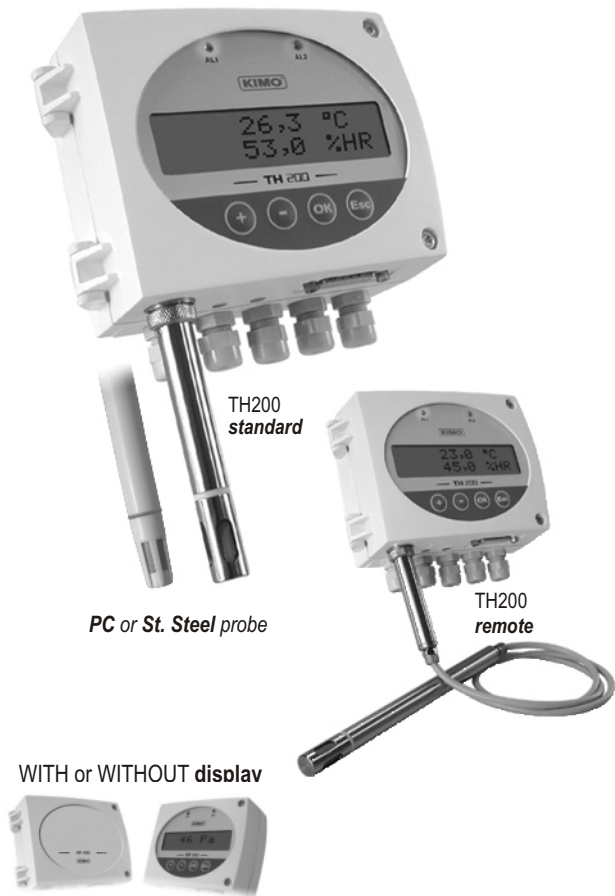

**Transmitter features**

**Humidity**

- Measuring range ..... 0 to 100 %RH  
 Units of measurement ..... %RH  
 Accuracy\* (Repeatability, linearity, hysteresis) ±1,5%RH (from 3 to 98%RH and if 15°C ≤ T ≤ 25°C)  
 Temperature dependence ..... ±0.04 x (T-20)%RH (if T < 15°C or T > 25°C)  
 Response time ..... <10 sec. (from 10% RH to 80%RH, V<sub>air</sub>=2m/s)  
 Resolution ..... 0,1 %RH  
 Factory calibration uncertainty ..... ±0.88%RH  
 Type of sensor ..... capacitive  
 Type of fluid ..... air and neutral gases (high resistance to solvents)

**Temperature**

- Measuring range ..... from -20 to +120°C ( polycarbonate probe)  
 ..... from -40 to +180°C (st. steel probe)  
 Units of measurement ..... °C, °F  
 Accuracy \* ..... ±0,3% of reading ±0,25°C  
 Response time ..... t<sub>0,9</sub> = 9 sec. for V<sub>air</sub>= 1 m/s  
 Resolution ..... 0,1°C  
 Type of sensor ..... Pt 100 1/3 as per DIN IEC 751  
 Type of fluid ..... air and neutral gases

\* All accuracies indicated in this technical datasheet were stated in laboratory conditions, and can be guaranteed for measurements carried out in the same conditions, or carried out with calibration compensation.  
 As per NFX 15-113 and the Charter 2000/2001 HYGROMETERS, GAL (Guaranteed Accuracy Limit) which has been calculated with a coverage factor value of 2 is ±2.58%RH between 18 and 28°C on the measuring range from 3 to 98%RH. Sensor drift is less than 1%RH/year.

**Functions**

Class 200 transmitters have 2 analogue outputs which correspond to the 2 parameters displayed. You can activate 1 or 2 outputs and for each output, you can choose between humidity, temperature and the functions below:

Features / Functions	Measuring ranges	Units and resolutions
Mixing ratio	from 2 to 900 g/Kg	0,1 g/kg
Dew point	from -80 to +180°C	0,1 °C - 0,1 °F
Wet temperature	from -20 to +180°C	0,1°C - 0,1 °F
Enthalpy	from 0 to 15 000 KJ/Kg	0,1 KJ/Kg

**Part number**

To order, just add the codes to complete the part number :

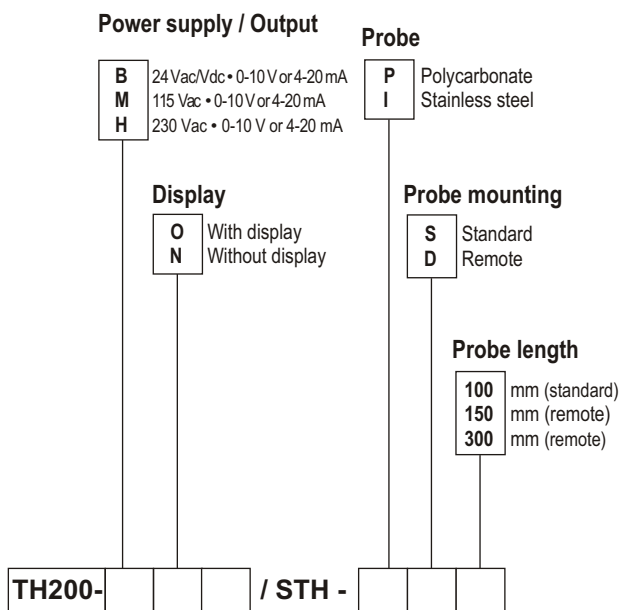

Example : TH200-BN/STH-PD300 = humidity transmitter type TH200, with 24Vac/Vdc power supply, without display with polycarbonate remote probe length 300mm.



- Easy maintenance with the new SMART-PRO system **digital probes**.
- **Totally interchangeable** : they are individually adjusted and are automatically recognized by the transmitter.

## Housing dimensions

(including wall-mounting plate)

### Standard

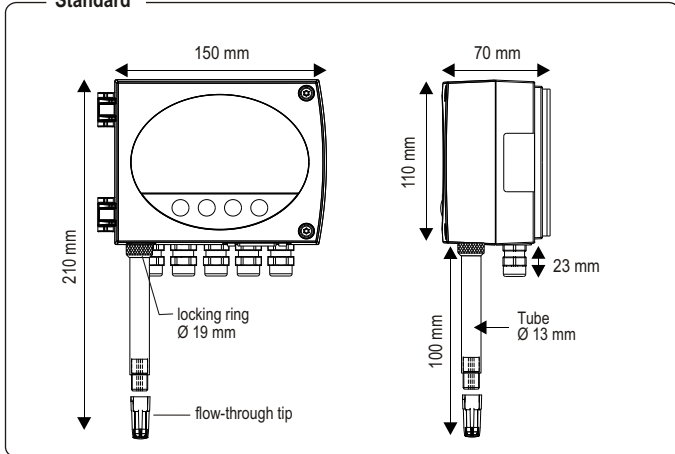

### Remote

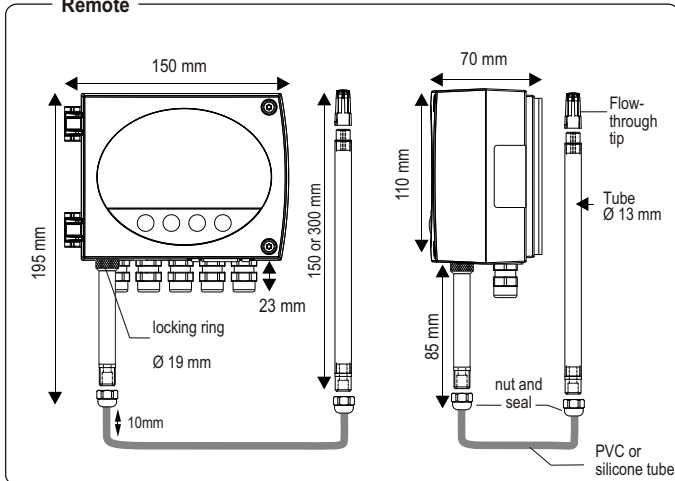

## Housing features

- Housing .....ABS  
 Fire-proof classification .....V 0 as per UL 94  
 Protection .....IP 65  
 Display .....alphanumeric, 2 lines of 16 digits,  
 98mm x 22mm, backlit  
 protection screen made of PMMA  
 Connection fittings .....polyamide for cables Ø 7 mm max.  
 Weight .....800 g (with display)

## Relays and Alarms

Class 200 transmitters have 4 stand-alone and configurable alarms :  
 2 visual alarms (dual color LED) and 2 relays (contacts).

### You can set :

- the parameter (humidity, temperature, dew point)
- 1 or 2 set points (high and low) for each alarm
- the time-delay / 60 sec. max
- the alarm action : rising or falling
- the relay operation mode : positive or negative security
- the audible alarm (buzzer) activation.

## Probes features

### Polycarbonate probes

- Measuring range.....-20 to +120°C  
 Standard probe.....Length 100 mm  
 Remote probe .....Length 150 or 300 mm  
 Cable .....PVC Ø 4,8 mm, length 2m

Polycarbonate probes are supplied with a flow-through polycarbonate protection tip with st. steel filter 25 (ref. EPP2).

### Stainless steel probe

- Measuring range.....-40 to +180°C  
 Standard probe.....Length 100 mm  
 Remote probe .....Length 150 or 300 mm  
 Cable .....silicone Ø 4,8 mm, lg 2 m

Stainless steel probes are supplied with a flow-through stainless steel protection tip with a st. steel filter 25 (ref. EPI25).

### Tip selection

Part number	EPP2	EPI25	EPI100	EPFI	EPFT
<b>Specifications</b>					
Tip material	PC <sup>(1)</sup>	St. steel <sup>(3)</sup>	St. steel <sup>(3)</sup>	St. steel <sup>(3)</sup>	PTFE <sup>(2)</sup>
Filter material	St. steel meshed	St. steel meshed	St. steel meshed	St. steel sintered	PTFE sintered
Filter type					
Maximum particles	25	25	100	10	50
Maximum air velocity	25m/s	25m/s	20m/s	30m/s	25m/s
Maximum temperature	120°C	180°C	120°C	180°C	180°C
Maximum relative humidity	95%RH	95%RH	100%RH	90%RH	90%RH
Length	30mm	30mm	30mm	30mm	30mm

### Applications

HVAC air-conditioning system	yes	yes			
Cold storage room			yes		yes
Industry	yes	yes	yes	yes	yes
Pharma plants / Electronics	yes	yes	yes	yes	yes
Dryer				yes	yes
Curing				yes	
Swimming-pool			yes		yes

### Harsh environments

Water droplets					yes
Shavings/cuttings		yes		yes	
Dust			yes		
Chemical products					yes
Grease					yes

(1) PC : Polycarbonate - (2) PTFE : Teflon® - (3) St. steel: 316 L

## Technical Specifications

- Power supply.....24 Vac / Vdc ±10%  
 115 Vac or 230 Vac ±10%, 50-60 Hz  
 Output .....2 x 4-20 mA or 2 x 0-10 V (4 wires)  
 maximum load : 500 Ohms (4-20 mA)  
 minimum load : 1 K Ohms (0-10 V)  
 Galvanic isolation .....inputs and outputs (115 Vac/230 Vac models)  
 outputs (24 Vac/Vdc models)  
 Consumption .....5 VA  
 Relays .....2 RCR relays 6A / 230 Vac  
 Visual alarms .....2 dual color LED  
 Audible alarm .....buzzer  
 Electro-magnetical compatibility.....EN 61 326  
 Electrical connection.....screw terminal block for cables Ø 1.5 mm<sup>2</sup> max  
 RS 232 communication.....Digital : ASCII, proprietary protocol  
 Working temperature (housing) .....0 to +50°C  
 Working temperature (probe).....-20 to +120°C (polycarbonate)  
 -40 to +180°C (st. steel)  
 Storage temperature.....-10 to +70°C  
 Environment.....air and neutral gases

## Connection

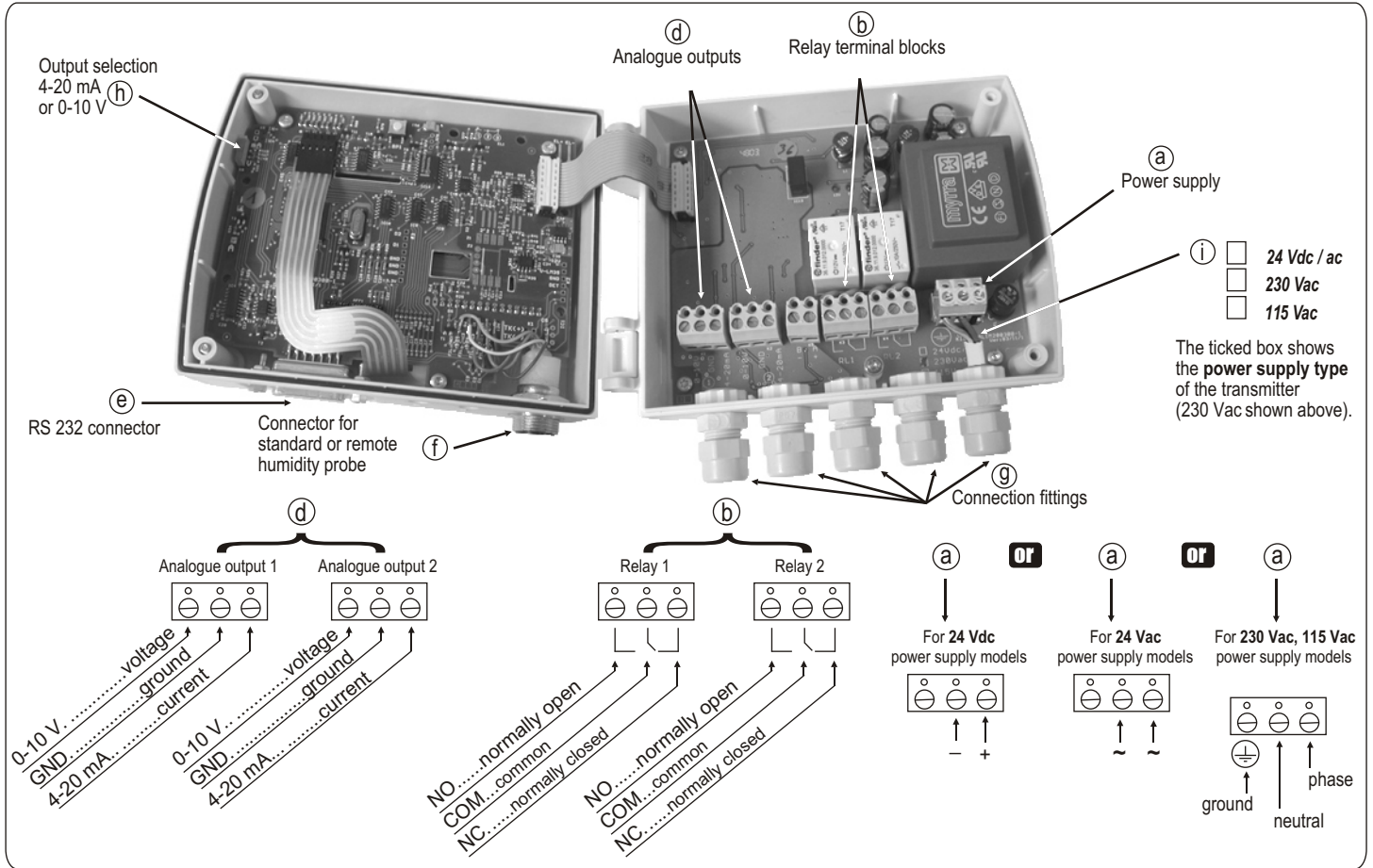

## Electrical connections - as per NFC15-100 norm

**!** This connection must be made by a qualified technician. **Whilst making the connection, the transmitter must not be energized.**

### Power supply connection :

**!** Before making the connection, you must first check the power supply which is indicated on the transmitter board (see (i) on connection drawing).

• For 24 Vdc power supply models :

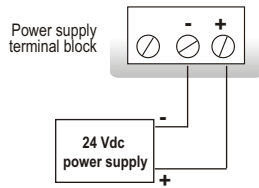

• For 24 Vac power supply models :

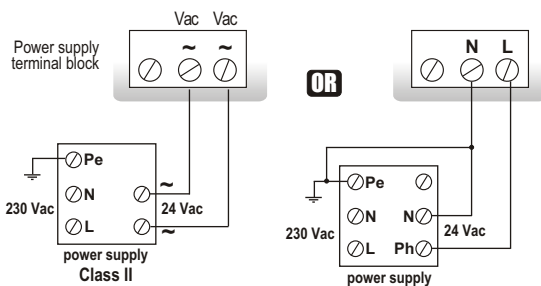

• For 115 or 230 Vac power supply models :

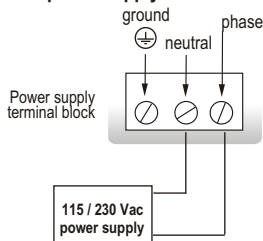

### Output signal selection voltage (0-10 V) or current (4-20 mA)

The on-off switch located on the left top of the transmitter (see (h) on connection drawing) allows selection of the required outputs.

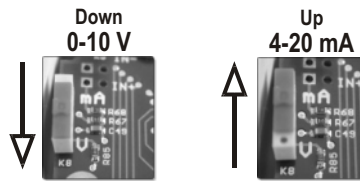

### Output connection :

• 4-20 mA current output :

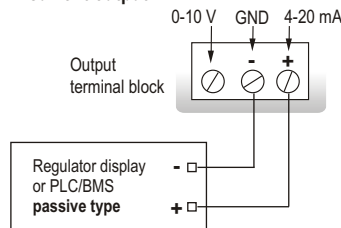

• 0-10 V voltage output :

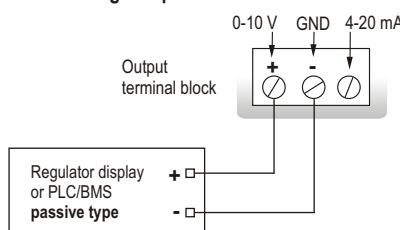

### Connection of SUB-D15 RS 232 (see (e) on connection drawing)

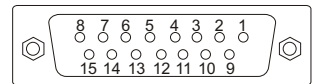

Pin #	Description
1	NC *
2	NC *
3	NC *
4	NC *
5	NC *
6	NC *
7	NC *
8	NC *
9	RX (RS 232)
10	NC *
11	TX (RS 232)
12	NC *
13	NC *
14	NC *
15	GND (RS 232)

**!** CAUTION :  
NC \* --> DO NOT CONNECT

## Digital communication

### RS 232 communication

• Via the RS 232 connection, the TH200 can transmit its measurements to a KIMO Class 300 transmitter.

Example : a CP300 can display (in addition to the pressure) other parameters such as humidity and temperature from a TH 200.

• Via the RS 232 connection, you can also configure your transmitter with the LCC-300

• The RS 232 connection cable is available in 2 m, 5 m or 10 m (maximum) lengths.



## Configuration

You can configure all the parameters of the transmitter : **units, measuring ranges, alarms, outputs, channels, calculation formula...** via the different methods shown below :

☛ **Via keypad** : only on models with display  
A code-locking system combined with keypad guarantees the security of the installation. See configuration manual.

☛ **Via software** (optional) : on all models.  
Simple user-friendly configuration. See LCC-300 user manual.

### Configurable analogue outputs

Configure the range according to your needs: outputs are automatically adjusted to the new measuring range.

Range with centre zero (-40/0/+40°C), with offset zero (-30/0/70°C), or standard range (0/100 °C) => you can configure your own intermediate ranges according to your needs, between 10% and 100% of the full scale.

The minimum configurable range is 10% of the full scale.

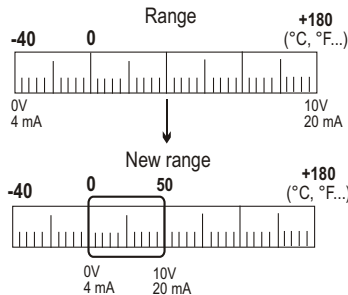

## Options

- LCC-300 configuration software with RS 232 cable
- Calibration certificate



## Optional accessories

- EHK 500 reference portable instrument
- Mounting brackets
- Sliding fittings
- Connection fittings
- Protection tips
- Caps for tips
- Wall-mounting support bracket for remote humidity probe.



## Calibration

### On-site adjusting and calibration :

The EHK 500 is a reference portable instrument which enables you to adjust at one point on the TH 200 and TH 300, by correcting any offset whilst measuring in a single ambient environment, housing both sensing elements. You can also adjust at several points.



### Output diagnostics :

With this function, you can check with a multimeter (or a regulator/display, or a PLC/BMS) if the transmitter outputs work properly. The transmitter generates a voltage of 0 V, 5 V and 10 V or a current of 4 mA, 12 mA and 20 mA.



### Certificate :

- Class 300 transmitters are supplied with adjusting certificates. Calibration certificates are offered as an option.
- The Smart-Pro humidity probes are supplied with adjusting certificates and can also be supplied with calibration certificates offered as an option.

## Mounting

To install the transmitter on a wall: fix the stainless steel plate to the wall (this plate is supplied with the transmitter).

Drill 8mm holes and mount the plate with the screws and wall-plugs supplied with the transmitter.

Insert the transmitter on the plate (see A on the drawing shown below), by aligning it at 30°. Rotate its housing in clockwise direction until you hear a "click" which confirms that the transmitter is correctly installed. Then, open the housing, lock the clamping system of the housing on the plate, with the screws as shown (to remove the transmitter from the plate, remember to remove the screws first).

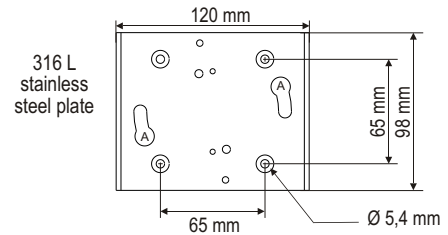
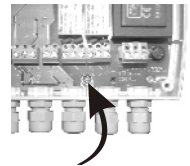

## Maintenance

Avoid aggressive solvents.

Protect the transmitter and probes from any cleaning product containing formol, which may be used for cleaning rooms or ducts.

[www.kimo.fr](http://www.kimo.fr)

EXPORT DEPARTMENT

Tel : + 33. 1. 60. 06. 69. 25 - Fax : + 33. 1. 60. 06. 69. 29

e-mail : [export@kimo.fr](mailto:export@kimo.fr)



Distributed by : **PRC Technologies Corp., Ltd.**

Tel : 02 530 1714, 02 530 1619, 02 530 1621

Fax : 02 530 1731

[info@prctech-th.com](mailto:info@prctech-th.com)